

SAT 120 S/LS

INSULATED SLIDING
SYSTEM

SAT 120 S/LS

YALITIMLI SÜRME SİSTEMİ



ACCURACY



HARMONY



BALANCE

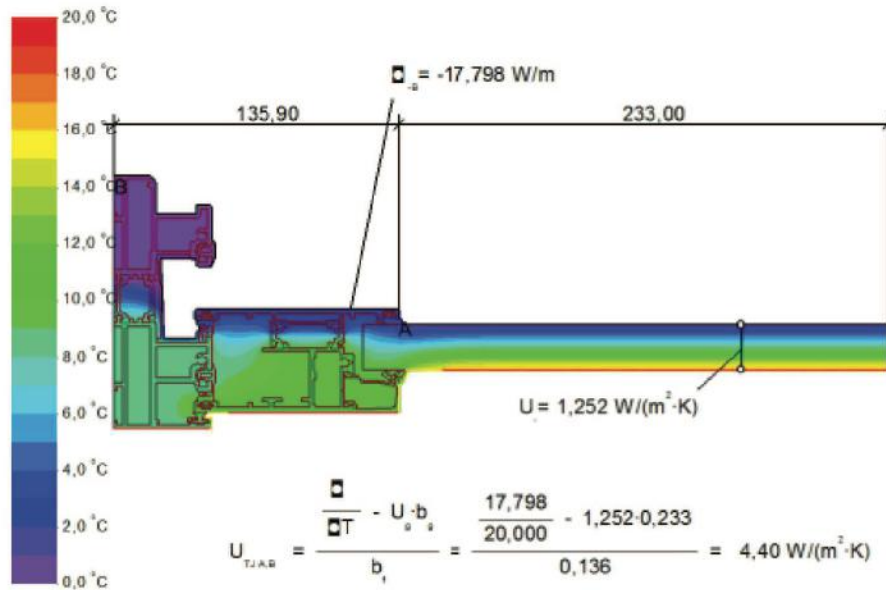

Material	λ [W/(m·K)]	μ
Aluminium (Si Alloys)	160,000	0,900
EPDM (ethylene propylene diene monomer)	0,250	0,900
PVC-U (polyvinylchloride), rigid	0,170	0,900
Panel	0,085	0,900
Polyamid (nylon)	0,250	0,900
Unventilated air cavity	anisotropic	
Boundary Condition	q [W/m²]	T [°C]
Epsilon 0.9		0,900
Exterior, normal	0,000	0,040
Interior, frame, normal	20,000	0,130
Interior, frame, reduced	20,000	0,200
Symmetry/Model section	0,000	

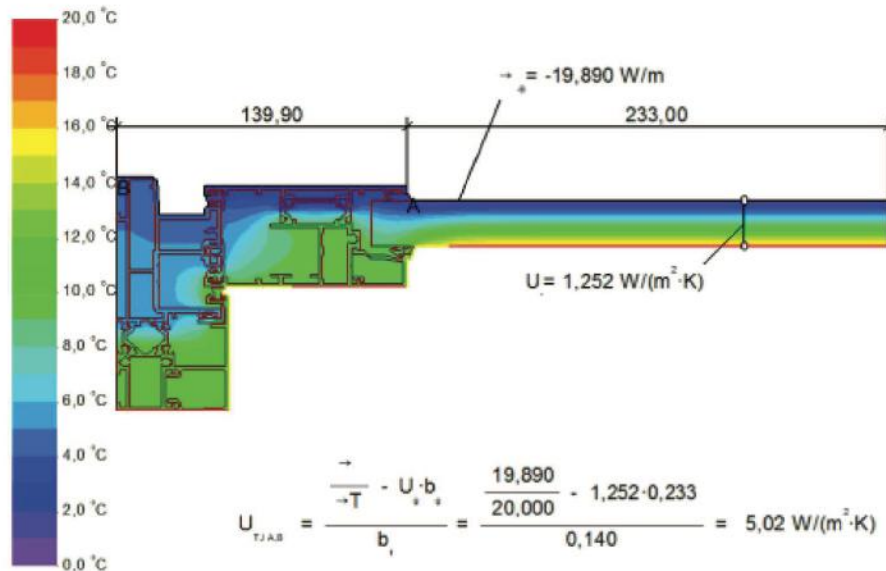

Material	λ [W/(m·K)]	μ
Aluminium (Si Alloys)	160,000	0,900
EPDM (ethylene propylene diene monomer)	0,250	0,900
PVC (polyvinylchloride), rigid	0,170	0,900
Panel	0,085	0,900
Polyamid (nylon)	0,250	0,900
Unventilated air cavity	anisotropic	
Epsilon 0.9		0,900
Exterior, normal	0,000	0,040
Interior, frame, normal	20,000	0,130
Interior, frame, reduced	20,000	0,200
Symmetry/Model section	0,000	

SAT 120 S/LS

YALITIMLI SÜRME SİSTEMİ

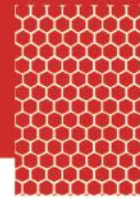

ACCURACY



HARMONY



BALANCE

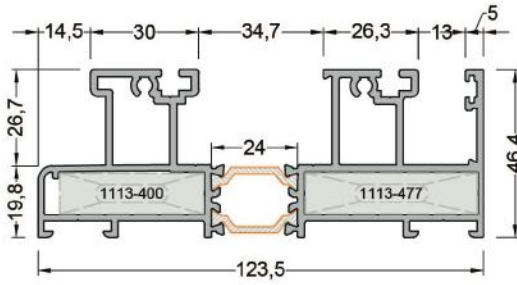

320-1202 (2,875 kg/mt)
SAT120 F07 2'LI KASA PROFİLİ

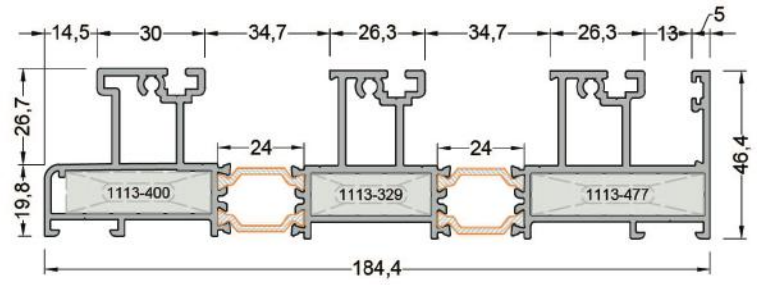

320-1302 (4,229 kg/mt)
SAT120 F05 3'LÜ KASA PROFİLİ

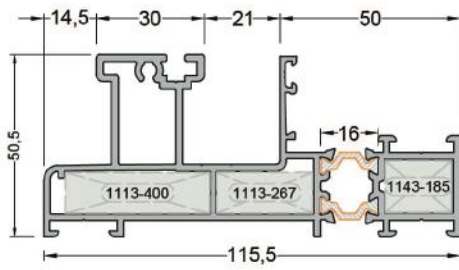

320-1102 (2,542 kg/mt)
SAT120 F10 MONORAIL KASA PROFİLİ

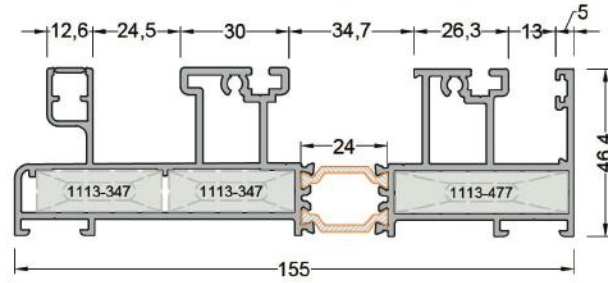

320-1203 (3,351 kg/mt)
SAT120 F11 SİNEKLİK RAYLI 2 Lİ KASA PROFİLİ

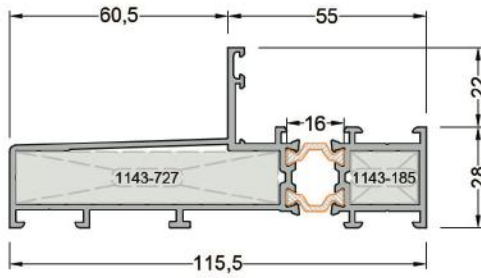

320-1404 (1,926 kg/mt)
SAT120F09 SABİT GEÇİŞ KASA PROFİLİ

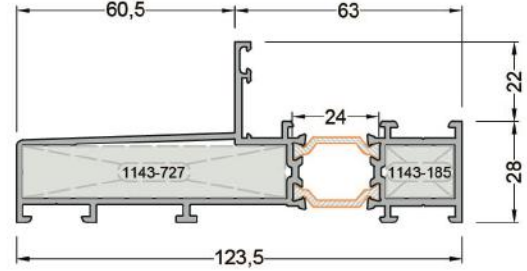

320-1403 (1,969 kg/mt)
SAT120F08 SABİT GEÇİŞ KASA PROFİLİ

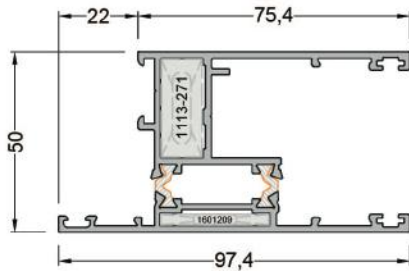

320-2101 (1,900 kg/mt)
SAT120V01 KALDIRSÜR KANAT PROFİLİ

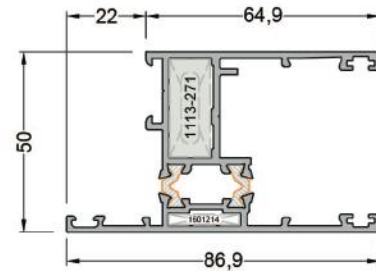

320-2102 (1,689 kg/mt)
SAT120V02 SÜRME KANAT PROFİLİ

SAT 120 S/LS

YALITIMLI SÜRME SİSTEMİ

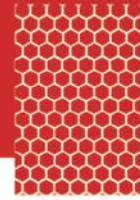

ACCURACY

HARMONY

BALANCE

WAT55M01 SEMBOLİKTİR. WAT55 SERİSİNE AİT
BÜTÜN ORTA KAYITLAR UYGULANABİLİR

WAT63M01 SEMBOLİKTİR. WAT63 SERİSİNE AİT
BÜTÜN ORTA KAYITLAR UYGULANABİLİR

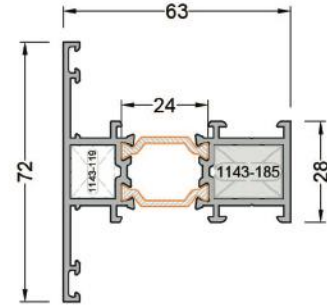
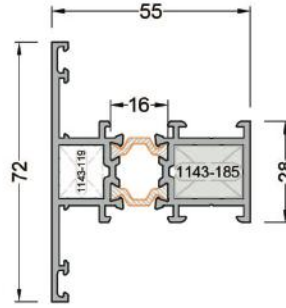
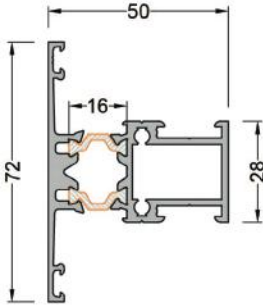

320-3101 (1,347 kg/mt)
SAT120M01 ORTA KAYIT PROFİLİ

255-2101 (1,505 kg/mt)
WAT55M01 ORTA KAYIT PROFİLİ

263-2101 (1,546 kg/mt)
WAT63M01 ORTA KAYIT PROFİLİ

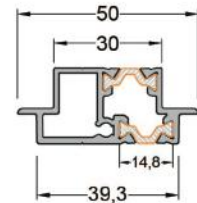
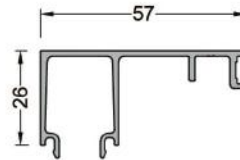
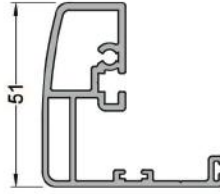
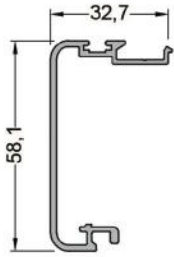

320-6009 (0,522 kg/mt)
SAT120C03 KENET PROFİLİ

320-6005 (1,059 kg/mt)
SAT120A04 KİLİT ADAPTÖR PR.

320-6008 (0,570 kg/mt)
SAT120C02 KASA KAPAMA PR.

320-6002 (0,760 kg/mt)
SAT120A01 4 KANAT ADAPTÖR

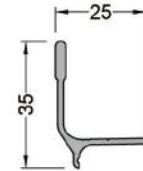
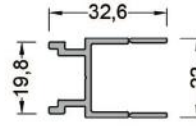
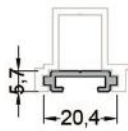
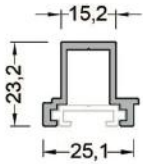

320-6003 (0,388 kg/mt)
SAT120A02 TİJ ADAPTÖRÜ

320-6004 (0,141 kg/mt)
SAT120A03 TİJ PROFİLİ

320-6010 (0,392 kg/mt)
SAT120A05 PVC İSP.ADAPTÖRÜ

320-6001 (0,276 kg/mt)
SAT120S01 SİN.DAMLALIK PR.

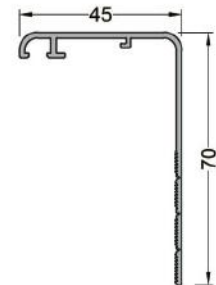
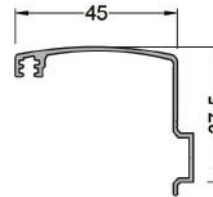
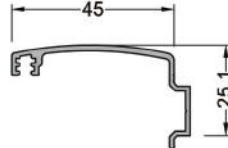
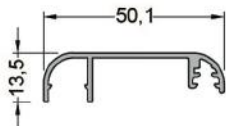

801-135 (0,357 kg/mt)
AW12 PERVAZ PROFİLİ

801-288 (0,347 kg/mt)
AW02 PERVAZ PROFİLİ

801-410 (0,349 kg/mt)
AW03 PERVAZ PROFİLİ

801-070 (0,525 kg/mt)
AW13 PERVAZ PROFİLİ

SAT 120 S/LS

YALITIMLI SÜRME SİSTEMİ

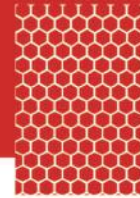

ACCURACY



HARMONY



BALANCE

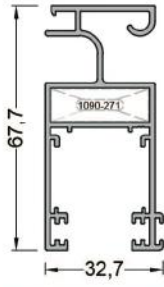

380-4006 (1,003 kg/mt)
SLA-S01 SİNEKLİK KANAT PR.



380-4003 (0,661 kg/mt)
S72S03 SİNEKLİK KANAT PR.

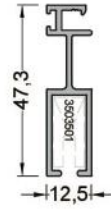

380-4002 (0,427 kg/mt)
SLA-S02 SÜRME SİNEKLİK PR.

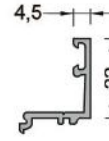

800-045 (0,227 kg/mt)
G045 CAM ÇİTASI

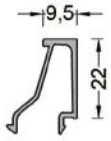

800-095 (0,232 kg/mt)
G095 CAMÇİTASI

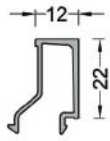

800-120 (0,237 kg/mt)
G120 CAMÇİTASI

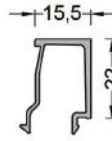

800-155 (0,249 kg/mt)
G155 CAMÇİTASI



800-175 (0,258 kg/mt)
G175 CAM ÇİTASI

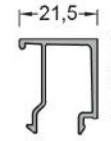

800-215 (0,273 kg/mt)
G215 CAMÇİTASI

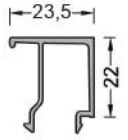

800-235 (0,280 kg/mt)
G235 CAMÇİTASI

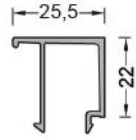

800-255 (0,285 kg/mt)
G255 CAMÇİTASI

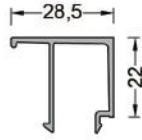

800-285 (0,296 kg/mt)
G285 CAMÇİTASI

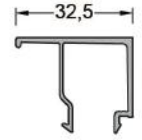

800-325 (0,313 kg/mt)
G325 CAMÇİTASI

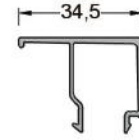

800-345 (0,319 kg/mt)
G345 CAMÇİTASI

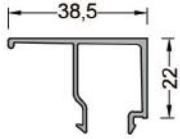

800-385 (0,332 kg/mt)
G385 CAMÇİTASI

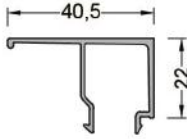

800-405 (0,337 kg/mt)
G405 CAMÇİTASI

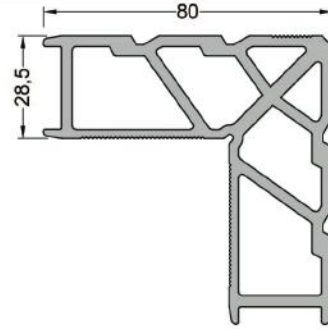

1285 (3,511 kg/mt)
L285 KÖŞE TAKOZU

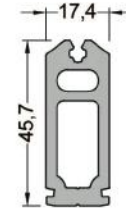

2198 (1,170 kg/mt)
DİK BAĞLANTI

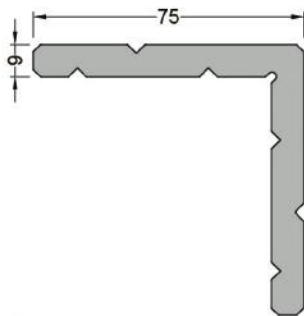

1090 (3,284 kg/mt)
L090 KÖŞE TAKOZU

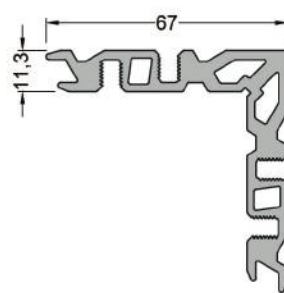

1113 (2,188 kg/mt)
L113 KÖŞE TAKOZU

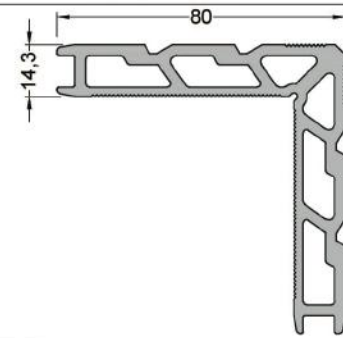

1143 (2,867 kg/mt)
L143 KÖŞE TAKOZU

SAT 120 S/LS

YALITIMLI SÜRME SİSTEMİ

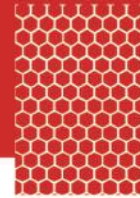

ACCURACY

HARMONY

BALANCE

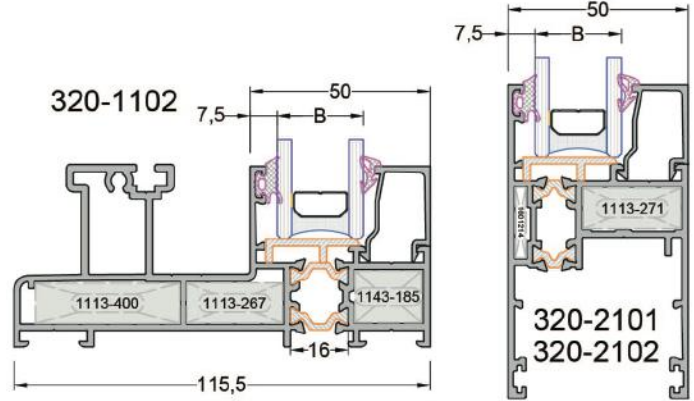
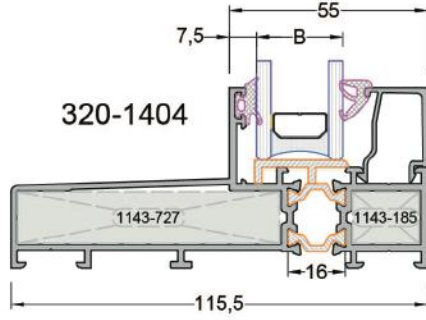

CAM ÖLÇÜLERİ (B)	DIŞ CAM FİTİLİ		İÇ CAM FİTİLLERİ				CAM ÇİTASI (A)
	3202206 3 mm	3202113 2-3 mm	3202114 4-5 mm	3202115 6-7 mm	3202116 8-9 mm		
4 mm	●						800-345
5 mm	●						800-345
6 mm	●						800-345
8 mm	●						800-345
10 mm	●	●					800-345
12 mm	●						800-285
16 mm	●	●					800-285
18 mm	●		●				800-255
20 mm	●	●					800-255
22 mm	●					●	800-175
24 mm	●				●		800-175
26 mm	●		●				800-175
28 mm	●	●					800-175
30 mm	●					●	800-095
32 mm	●				●		800-095
34 mm	●		●				800-095
36 mm	●	●					800-095

CAM ÖLÇÜLERİ (B)	DIŞ CAM FİTİLİ		İÇ CAM FİTİLLERİ				CAM ÇİTASI (A)
	3202206 3 mm	3202113 2-3 mm	3202114 4-5 mm	3202115 6-7 mm	3202116 8-9 mm		
4 mm	●						800-325
5 mm	●						800-325
6 mm	●						800-325
8 mm	●						800-285
10 mm	●						800-285
12 mm	●		●				800-285
16 mm	●						800-215
18 mm	●		●				800-215
20 mm	●					●	800-155
22 mm	●					●	800-155
24 mm	●		●				800-155
26 mm	●					●	800-095
28 mm	●					●	800-095
30 mm	●		●				800-095
32 mm	●					●	800-045
34 mm	●					●	800-045
36 mm	●		●				800-045

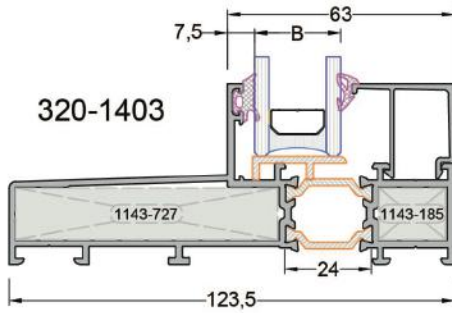

CAM ÖLÇÜLERİ (B)	DIŞ CAM FİTİLİ		İÇ CAM FİTİLLERİ				CAM ÇİTASI (A)
	3202206 3 mm	3202113 2-3 mm	3202114 4-5 mm	3202115 6-7 mm	3202116 8-9 mm		
8 mm	●						800-405
10 mm	●						800-405
12 mm	●		●				800-405
16 mm	●						800-345
18 mm	●		●				800-345
20 mm	●					●	800-285
22 mm	●					●	800-285
24 mm	●		●				800-285
26 mm	●					●	800-235
28 mm	●					●	800-235
30 mm	●		●				800-235
32 mm	●					●	800-175
34 mm	●					●	800-175
36 mm	●	●					800-175

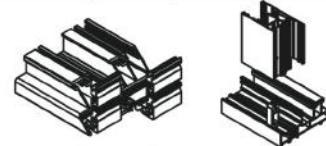

KÖŞE / DİK BAĞLANTI SEÇİM LİSTESİ

PROFİL KODU	KÖŞE TAKOZU PARÇA KODU	KESİM ÖLÇÜSÜ	KÖŞE TAKOZU
320-1202	1113-400	40,0 mm	1113
	1113-477	47,7 mm	
320-1302	1113-400	40,0 mm	1113
	1113-329	32,9 mm	
320-1102	1113-477	47,7 mm	1113
	1113-400	40,0 mm	
320-1403	1113-267	26,7 mm	1113
	1143-185	18,5 mm	
320-1404	1113-347	34,7 mm	1113
	1113-347	34,7 mm	
320-2101	1113-477	47,7 mm	1113
	1143-727	72,7 mm	
320-2102	1143-185	18,5 mm	1113
	1143-727	72,7 mm	
320-2102	1601209	KÖŞE ÇAVUŞ	1113
	1113-271	27,1 mm	
320-2102	1601214	KÖŞE ÇAVUŞ	1113
	1113-271	27,1 mm	
320-2101	2198-113	11,3 mm	2198
320-2102			

SAT 120 S/LS

YALITIMLI SÜRME SİSTEMİ

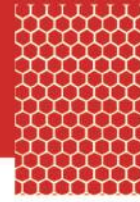

ACCURACY

HARMONY

BALANCE

ÜRÜN ÇİZİMİ	ÜRÜN KODU	ÜRÜN ADI
	3202206	DIŞ CAM FİTİLİ 3 mm
	3202113	İÇ CAM FİTİLİ 2-3 mm
	3202114	İÇ CAM FİTİLİ 4-5 mm
	3202115	İÇ CAM FİTİLİ 6-7 mm
	3202116	İÇ CAM FİTİLİ 8-9 mm
	3202302	KANAT FİTİLİ 03F-07
	3202603	FİTİL KASA KAPAMA 05F-03
	3202704	KANAT KENET FİTİLİ SAT120
	3202604	KAPAK FİTİLİ 05F-04
	6502601	SİNEKLİK FİTİLİ 5 mm
	3203009	KİL FİTİL 6.7*550 MM
	3203007	ASETATLI KİL FİTİL 6.7*550 MM
	3203002	ASETATLI KİL FİTİL 4.8*650 SF-02
	7803102	MERKEZİ KANAL PVC 120-P01
	7803105	SÜRME KENET PVC S120-P02
	3503910	SIZDIRMAZLIK TAKOZU S120-A07
	3501903	SIZDIRMAZLIK TAKOZU S120-A08
	3503906	ALT HAVA KESİCİ S120-A03
	3503907	ALT HAVA KESİCİ S120-A05 320-1102 İÇİN
	3503908	ÜST HAVA KESİCİ S120-A02
	3503909	ÜST HAVA KESİCİ S120-A04 320-1102 İÇİN
	3501904	SPACER S120-A01
	5303208	CAM TAKOZU

ÜRÜN ÇİZİMİ	ÜRÜN KODU	ÜRÜN ADI
	1601952	PROFİL TESPİT APARATI
	6503406	SİNEKLİK KÖŞE TAKOZU SL-100
	3507902	PASLANMAZ SÜRME RAY PROFİLİ S120-R01
	3503600	SÜRME KENET KAPAK S120 P06
	3501510	AYARLI RULMAN 13-135
	3501512	AĞIR YÜK RULMAN
	3501509	SÜRME RULMAN 13-120N
	0201017	EKSENEL KOL İTHAL
	0201018	EKSENEL KOL KİLİTLİ İTHAL
	0101933	PENCERE KOLU İTHAL
	0101934	PENCERE KOLU İTHAL-SAĞ
	0101935	PENCERE KOLU İTHAL-SOL
	3601102	KANAT ÇEKME KOL
	3516060	SÜRME İSPANYOLET 600/25
	3516080	SÜRME İSPANYOLET 800/25
	3516100	SÜRME İSPANYOLET 1000/25
	3516140	SÜRME İSPANYOLET 1400/25
	3516160	SÜRME İSPANYOLET 1600/25
	3516180	SÜRME İSPANYOLET 1800/25
	3501300	İSPANYOLET KARŞILIK
	0301100	KİLİT HAVUZLU 08-115
	0301103	SÜRME HAVUZ KOL OTOMATİK
	0301104	SÜRME KOL

ÜRÜN ÇİZİMİ	ÜRÜN KODU	ÜRÜN ADI
	3501920	HAVUZ KOL KARŞILIK
	233004	SABİT KANAT SEVİYE TAKOZU
	2311	ATRIA KALDIR-SÜR KOL BARELLİ
	2312	ATRIA KALDIR-SÜR KOL
	2315	ATRIA KALDIR-SÜR KOL BARELLİ +ATRIA ÇEKME KOL
	2316	ATRIA KALDIR-SÜR KOL+ATRIA ÇEKME KOL
	2313	ATRIA KALDIR-SÜR ÇİFT TARAFLI KOL BARELLİ
	2314	ATRIA KALDIR-SÜR ÇİFT TARAFLI KOL
	234101	TEK KANAT KİLİTLEME GRUBU
	235203	SEVİYELEME APARATI
	236004	14 mm VİDA SETİ
	233001	KALDIR&SÜR ÖN ARABA TAKIMI
	233002	KALDIR&SÜR ARKA ARABA TAKIMI
	233004	KALDIR&SÜR İLAVE ARABA TAKIMI
	234001	KALDIR&SÜR İSPANYOLET 2100 mm
	234002	KALDIR&SÜR İSPANYOLET 2400 mm
	234003	KALDIR&SÜR İSPANYOLET 2700 mm
	1601200	KÖŞE GÖNYE
	1601201	KÖŞE GÖNYE
	160301	KÖŞE GÖNYE
	1601209	KÖŞE ÇAVUŞU 320-2101 İÇİN
	1601214	KÖŞE ÇAVUŞU 320-2102 İÇİN

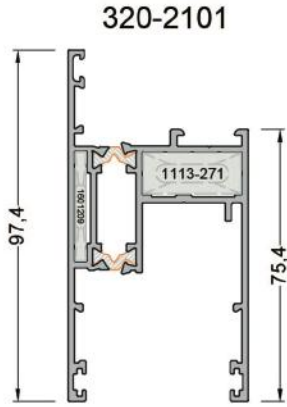
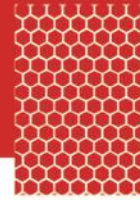

ÜRÜN ÇİZİMİ DRAWING	ÜRÜNÜN KODU PRODUCT REFERENCE	ÜRÜN ADI PRODUCT NAME
	3501801 320-2101 için	PVC İSPANYOLET ALT BESLEME PARÇASI PVC SLIDING ESPAGNOLETTE ADAPTER 600/25 mm
	3501802 320-2101 için	PVC İSPANYOLET ALT BESLEME PARÇASI PVC SLIDING ESPAGNOLETTE ADAPTER 800/25 mm
	3501803 320-2101 için	PVC İSPANYOLET ALT BESLEME PARÇASI PVC SLIDING ESPAGNOLETTE ADAPTER 1000/25 mm
	3501804 320-2101 için	PVC İSPANYOLET ALT BESLEME PARÇASI PVC SLIDING ESPAGNOLETTE ADAPTER 1200/25 mm
	3501805 320-2101 için	PVC İSPANYOLET ALT BESLEME PARÇASI PVC SLIDING ESPAGNOLETTE ADAPTER 1400/25 mm
	3501806 320-2101 için	PVC İSPANYOLET ALT BESLEME PARÇASI PVC SLIDING ESPAGNOLETTE ADAPTER 1600/25 mm
	3501807 320-2101 için	PVC İSPANYOLET ALT BESLEME PARÇASI PVC SLIDING ESPAGNOLETTE ADAPTER 1800/25 mm
	3501808 320-2101 için	PVC İSPANYOLET ALT BESLEME PARÇASI PVC SLIDING ESPAGNOLETTE ADAPTER 2000/25 mm

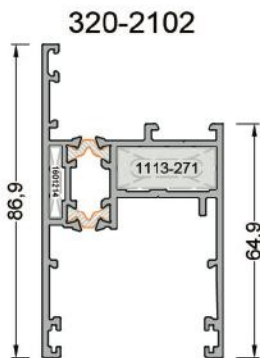

ÜRÜN ÇİZİMİ DRAWING	ÜRÜNÜN KODU PRODUCT REFERENCE	ÜRÜN ADI PRODUCT NAME
	3501809 320-2102 için	PVC İSPANYOLET ALT BESLEME PARÇASI PVC SLIDING ESPAGNOLETTE ADAPTER 600/25 mm
	3501810 320-2102 için	PVC İSPANYOLET ALT BESLEME PARÇASI PVC SLIDING ESPAGNOLETTE ADAPTER 800/25 mm
	3501811 320-2102 için	PVC İSPANYOLET ALT BESLEME PARÇASI PVC SLIDING ESPAGNOLETTE ADAPTER 1000/25 mm
	3501812 320-2102 için	PVC İSPANYOLET ALT BESLEME PARÇASI PVC SLIDING ESPAGNOLETTE ADAPTER 1200/25 mm
	3501813 320-2102 için	PVC İSPANYOLET ALT BESLEME PARÇASI PVC SLIDING ESPAGNOLETTE ADAPTER 1400/25 mm
	3501814 320-2102 için	PVC İSPANYOLET ALT BESLEME PARÇASI PVC SLIDING ESPAGNOLETTE ADAPTER 1600/25 mm
	3501815 320-2102 için	PVC İSPANYOLET ALT BESLEME PARÇASI PVC SLIDING ESPAGNOLETTE ADAPTER 1800/25 mm
	3501816 320-2102 için	PVC İSPANYOLET ALT BESLEME PARÇASI PVC SLIDING ESPAGNOLETTE ADAPTER 2000/25 mm

SAT 120 S/LS

YALITIMLI SÜRME SİSTEMİ



ACCURACY



HARMONY



BALANCE

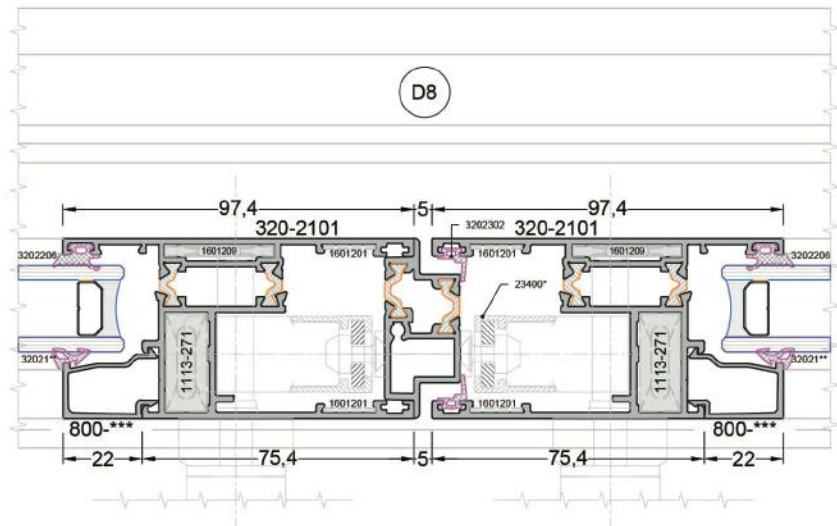
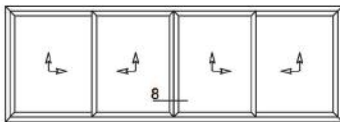
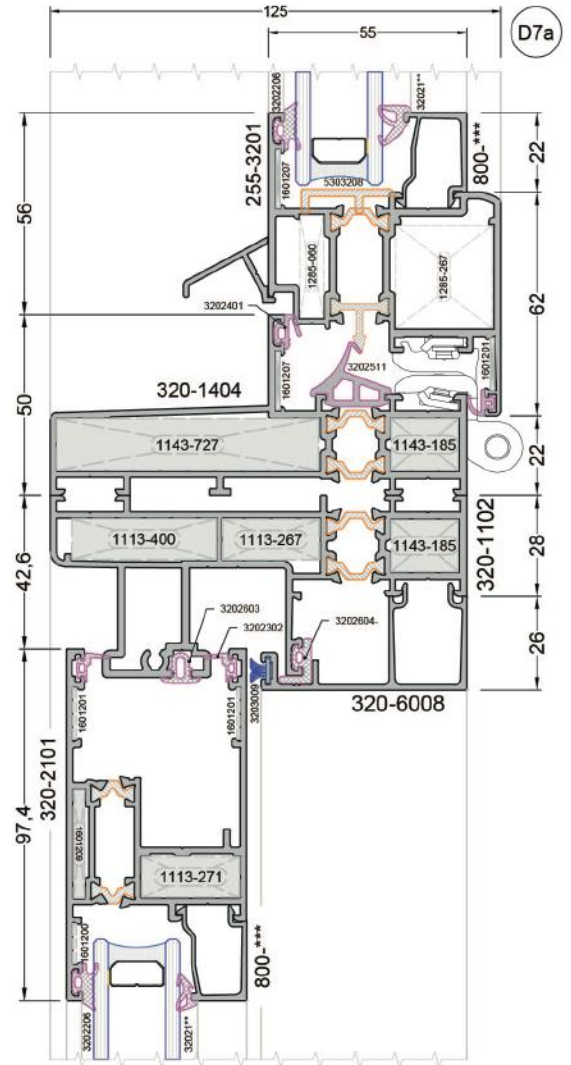
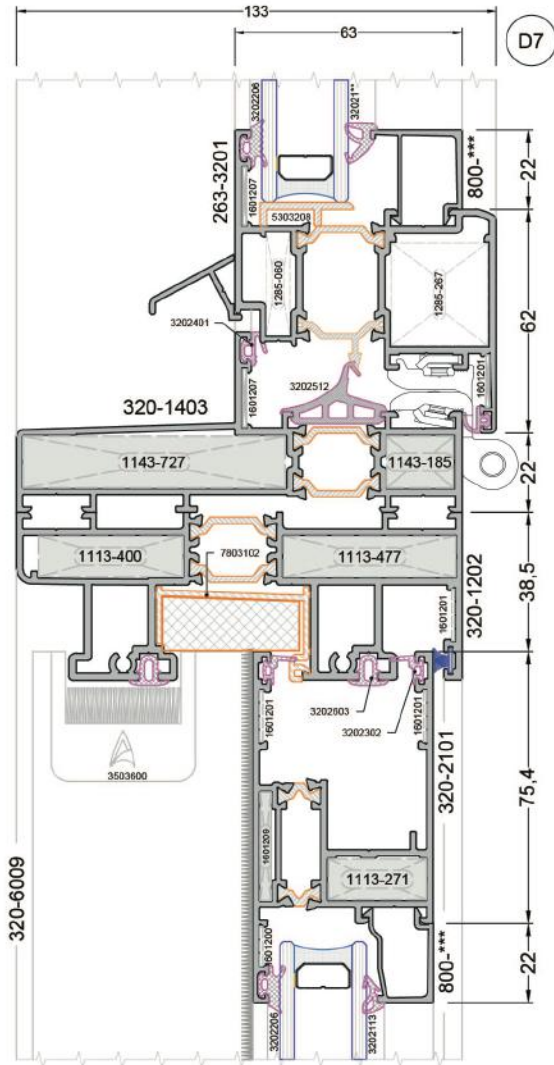
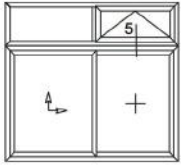

SAT 120 S/LS

YALITIMLI SÜRME SİSTEMİ

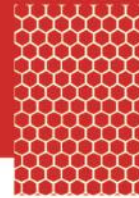

ACCURACY



HARMONY



BALANCE

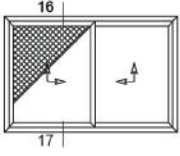

D16

D16a

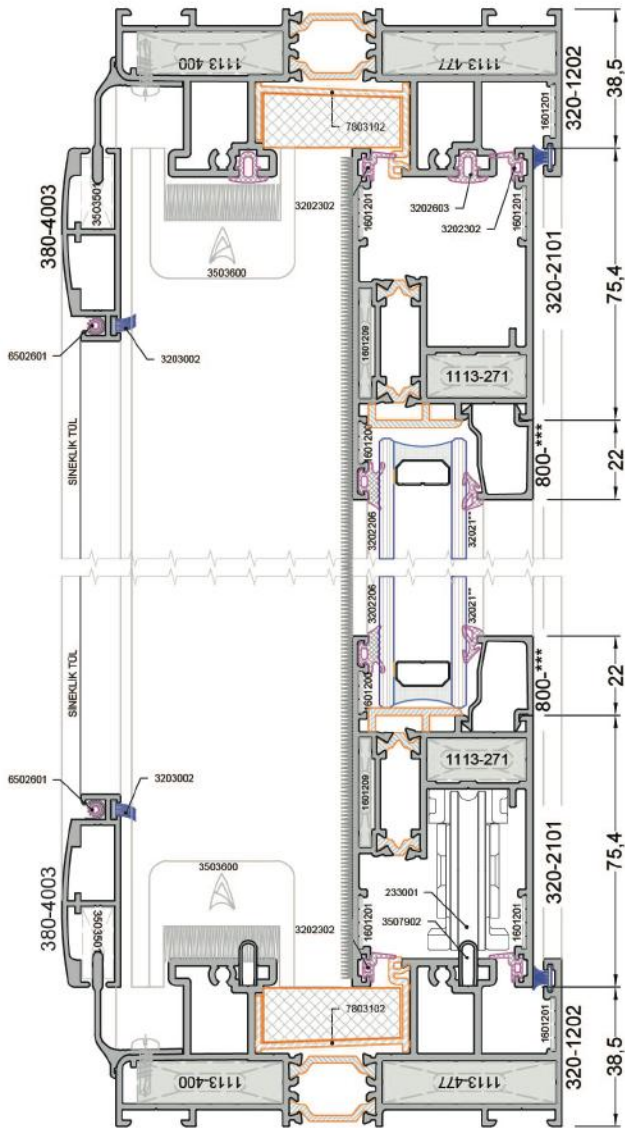

D17

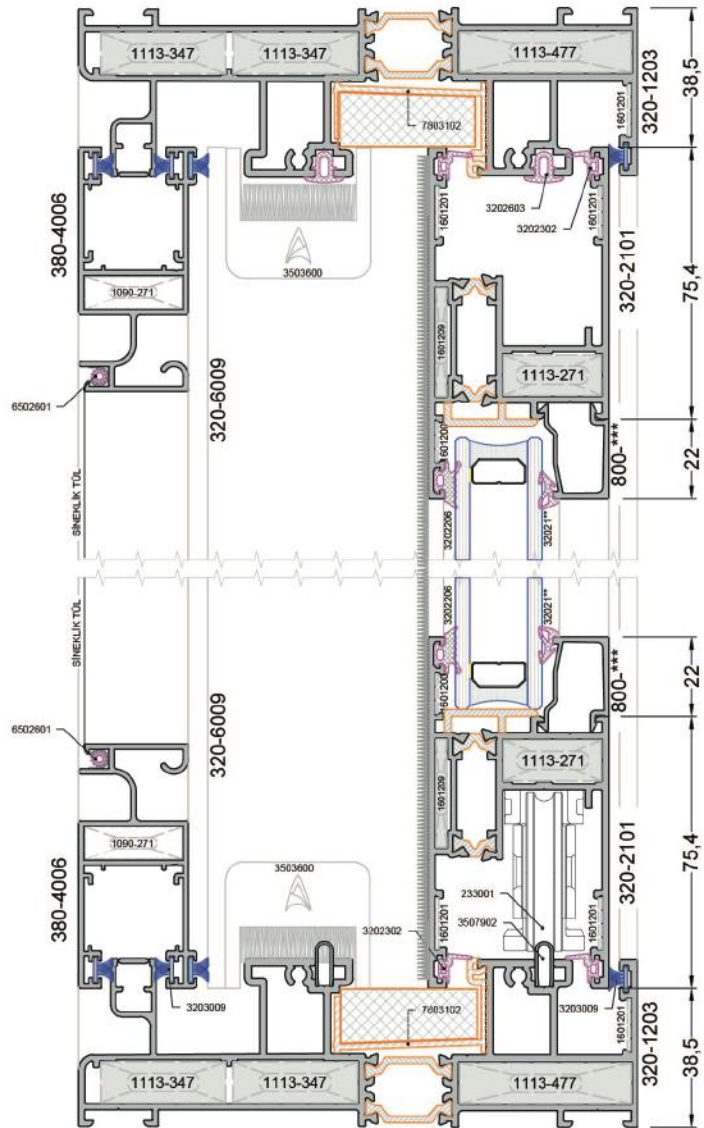

D17a

